

CLARKE®

WOODWORKER



8" (200MM) TABLE SAW

MODEL NO: CTS800C

PART NO: 6500724

OPERATION & MAINTENANCE INSTRUCTIONS



ORIGINAL INSTRUCTIONS

GC0321

INTRODUCTION

Thank you for purchasing this CLARKE product. This table saw has been designed to perform the sawing operation of ripping, cross-cutting, bevelling and mitering wood and wood products. This unit is designed for use with an 8" (200mm) carbide tipped blade.

Before attempting to use this product, please read this manual thoroughly and follow the instructions carefully. In doing so you will ensure the safety of yourself and that of others around you, and you can look forward to your purchase giving you long and satisfactory service.

SPECIFICATIONS

Model	CTS800C
Voltage	230V - 50 Hz
Power input	500 W
No-load speed	2950 rpm
Ingress protection (IP) rating	IP0X
Table size	505 mm x 373 mm
Dust Extractor connector	32 (internal) / 36 mm (external)
Blade size:	Outside Diameter 200 mm
	Bore Diameter 16 mm
	Thickness 2.4 mm
	Number of teeth 24 TCT
Maximum cut depth @ 90 Degrees	40 mm
Maximum cut depth @ 45 Degrees	22 mm
Machine weight:	10.8 kg
Machine size (L x W x H)	538 x 373 x 330mm
Sound pressure level LpA	87.2 dB (A)
Sound power level LWA:	100.2 dB (A)

This saw is NOT suitable for cutting:

- Timber greater than 40mm
- Metal, stone, rubber, plastic etc
- Logs or round timber

GUARANTEE

This product is guaranteed against faulty manufacture for a period of 12 months from the date of purchase. Please keep your receipt which will be required as proof of purchase.

This guarantee is invalid if the product is found to have been abused or tampered with in any way, or not used for the purpose for which it was intended. Faulty goods should be returned to their place of purchase, no product can be returned to us without prior permission.

This guarantee does not effect your statutory rights.

ENVIRONMENTAL RECYCLING POLICY







By purchasing this product, the customer is taking on the obligation to deal with its safe disposal in accordance with the Waste Electrical and Electronic Equipment (WEEE).

In effect, this means that this product must not be disposed of with general household waste. It must be disposed of according to the laws governing Waste Electrical and Electronic Equipment (WEEE) at a recognised disposal facility.

If disposing of this product or any damaged components, do not dispose of with general waste. This product contains valuable raw materials. Metal products should be taken to your local civic amenity site for recycling of metal products.

SAFETY SYMBOLS

	Read instruction manual before use		Wear dust mask
	Wear safety glasses		Wear ear defenders
	Indoor Use Only		

The above safety symbols appear on the product.

SAFETY WARNINGS



CAUTION: DO NOT LET FAMILIARITY WITH YOUR TABLE SAW MAKE YOU CARELESS. REMEMBER THAT A CARELESS FRACTION OF A SECOND IS SUFFICIENT TO CAUSE SEVERE INJURY.

PERMITTED USAGE

The table saw is constructed exclusively for the sawing of wood. The appropriate saw blade should be fitted according to the wood type (solid wood, chipboard or plywood).

- Read and understand the entire owner's manual before attempting assembly or operation.
- Read and understand the warnings posted on the machine and in this manual. Failure to comply with all of these warnings may cause serious injury.

HEALTH

When sawing, dust particles will be produced. In some instances this dust can be harmful (e.g. lead from old gloss paint, arsenic and chromium from chemically treated lumber).

To reduce the risk you should:

- Work in a well-ventilated area.
- Work with approved safety equipment, such as dust masks that are specially designed to filter microscopic particles.
- If possible use/connect to a suitable dust extractor.

GENERAL

1. DO NOT expose the saw to rain.
2. DO NOT use the saw in damp or wet conditions.
3. Keep the work area well lit.
4. DO NOT use the saw in the presence of flammable liquids and gases.
5. Remove loose items and unnecessary work pieces from the area before starting the saw.
6. Clean out sawdust from the interior of the saw to prevent a potential fire hazard. Attach a vacuum cleaner to the dust port for additional sawdust removal.
7. Wear ear protectors (plugs or muffs) during extended periods of operation.
8. Wear safety glasses. Everyday eyeglasses are not suitable as safety glasses.
9. Wear a dust mask when sawing wood.
10. NEVER wear gloves during operation.
11. Before operating this table saw, remove any neck tie, rings, watches and other jewellery and roll sleeves up past the elbows. Remove all loose clothing and confine long hair. Non-slip footwear or anti-skid floor strips are recommended.
12. Make sure that the machine stands stable on a firm surface.
13. Before use, carefully check the saw and mains cable for damage or any other condition that may affect its operation. Do not use the saw if any part is damaged or defective.
14. DO NOT use the saw if the switch does not turn it on and off.
15. Remove keys and wrenches. Ensure that keys and wrenches are removed from the saw before turning it on following blade replacement.
16. Use the right tool for the task - DO NOT force small tools to do the job of a heavy duty tool. It will do the job better and safer at the rate for which it was intended. Do not use tools for purposes not intended; for example DO NOT use table saws to cut tree limbs or logs.
17. The use of any accessory or attachment other than one recommended in this instruction manual may present a risk of personal injury.
18. Connect table saws to a dust-collecting device when sawing wood.

19. Guard against electric shock - Avoid body contact with earthed or grounded surfaces..
20. Extension cables - Before use, inspect the extension cable and replace if damaged. When using the tool outdoors, only use extension cables intended for outdoor use and marked accordingly.
21. Avoid unintentional starting. Make sure the switch is in the OFF position before connecting the machine to the power supply.
22. DO NOT abuse the cable. Never yank the cable to disconnect it from the mains supply. Keep the cable away from heat, oil, water and sharp edges.
23. This table saw is designed and intended for use by properly trained and experienced personnel only. If you are not familiar with the proper and safe operation of a table saw, DO NOT use until proper training and knowledge have been obtained.
24. Stay alert, watch what you are doing. Use common sense. DO NOT operate the saw when you are tired.
25. DO NOT operate this saw while tired or under the influence of drugs, alcohol or any medication.
26. Keep hands clear of the saw blade.
27. Maintain a balanced stance at all times so that you do not fall on to the blade. DO NOT overreach or use excessive force to perform any operation.
28. Use push-sticks or push blocks to feed the workpiece past the saw blade. Keep your hands and fingers well away from the blade.
29. The push-stick should always be stored with the machine when not in use.
30. Pay particular attention to instructions on reducing risk of kickback.
31. NEVER perform any operation freehand, which means using only your hands to support or guide the workpiece. Always use either the fence or the mitre fence to position and guide the work.



WARNING: FREEHAND CUTTING IS THE MAJOR CAUSE OF KICKBACK AND FINGER AMPUTATIONS.

-
32. Give your work undivided attention. Looking around, carrying on a conversation and “horse-play” are careless acts that can result in serious injury.
 33. When not in use, store the saw in a dry place out of reach of children.
 34. Replace the warning labels if they become obscured or removed.

35. Turn off and unplug the saw before cleaning. Use a brush or compressed air to remove chips or debris — DO NOT use your hands.
36. Disconnect the saw from the mains supply before changing blades or carrying out maintenance.
37. Keep blades sharp and clean for better and safer performance. Inspect power cables periodically and if damaged have them repaired.
38. Repairs should only be carried out by qualified persons using original spare parts, otherwise this may result in considerable danger to the user.
39. Keep handles dry, clean and free from oil and grease.
40. Unplug the saw - switch off and wait for the blade to come to a complete standstill before leaving it unattended.

ADDITIONAL SAFETY RULES FOR TABLE SAWS

1. The thickness of the saw blade must be greater than the thickness of the riving knife.
2. DO NOT stand on the table saw.
3. During transportation make sure that the upper part of the saw blade is covered by the guard.
4. DO NOT use the guard for handling or transportation.
5. Check that the workpiece is properly supported. Always provide additional support for long workpieces.
6. DO NOT exert side pressure on the saw blade.
7. Make sure that the blade rotates in the correct direction and that the teeth are pointing to the front of the saw.
8. DO NOT apply lubricants to the blade when it is running.
9. NEVER reach around or over the saw blade. NEVER reach for a workpiece until the saw blade has completely stopped.
10. Make sure that the blade and retaining discs are clean. Tighten the retaining screw securely.
11. Keep the saw blade sharp.
12. Make sure that the riving knife is adjusted to the correct distance from the blade.
13. NEVER operate the saw without the guard in place.
14. DO NOT use abrasive discs or diamond cutting wheels.
15. Rebating, slotting or grooving is not allowed.
16. DO NOT use a moulding head cutter with this saw.

17. Remove the rip fence when crosscutting. Never use the rip fence as a cut-off gauge when crosscutting.
18. Knock out any loose knots from the workpiece before you begin to cut.
19. Provide adequate support to the rear and the sides of the saw table for long or wide workpieces.
20. NEVER leave the saw running unattended. Turn the power off and do not leave the saw until it comes to a complete stop.
21. Before using the saw on an actual workpiece, let it run for a few moments. Watch for vibration or wobbling that could indicate poor installation or a poorly balanced blade.
22. Always hold work firmly against the mitre gauge or rip fence.
23. NEVER stand or have any part of your body in line with the path of the saw blade. Keep your hands out of the saw blade path.
24. Feed work into the blade against the direction of rotation only.
25. NEVER attempt to free a stalled saw blade without first turning the saw off. Turn the power switch off immediately to prevent motor damage.
26. Avoid awkward operations and hand positions where a sudden slip could cause your hand to move into the saw blade.
27. Avoid abrupt, fast feeding. Feed as slowly as possible when cutting hard workpieces. Do not bend or twist the workpiece while feeding. If you stall or jam the blade in the workpiece, turn the table saw off immediately. Unplug the saw, then clear the jam.
28. NEVER remove cut-off pieces near the blade or touch the blade guard while the blade is running.

SAW BLADES

1. The maximum speed of the saw blade must always be equal to or greater than the no-load speed of the table saw as specified on the rating plate.
2. Only use saw blades recommended by the manufacturer and which are the exact bore and diameter required for this machine. Do not use any spacers to make a blade fit onto the spindle. Use only the blades specified in this manual, which are manufactured in accordance with EN 847-1 standards.
3. Clean the spindle, retaining discs (especially the installing surface) and retaining bolt before installing the blade. Poor installation may cause vibration/wobbling or slippage of the blade.
4. DO NOT use saw blades which are damaged or deformed.
5. Take care that the selection of the saw blade is suitable for the material to be cut.

6. Make sure the blade is not contacting the riving knife or workpiece before the switch is turned on.
7. Wear gloves when handling saw blades and rough material. Saw blades shall be carried in a holder whenever practicable.

KICKBACK

Kickback is a sudden reaction to a pinched, bound or misaligned saw blade, it causes the workpiece to be ejected from the tool back towards the operator. Kickbacks can lead to serious personal injury.

You can avoid kickbacks by:

- a. Keeping the blade sharp,
- b. Keeping the rip fence parallel to the blade,
- c. Keeping the riving knife and blade guard in place and operating properly,
- d. Not releasing the workpiece until you have pushed it all the way past the blade,
- e. Not ripping a workpiece that is twisted or warped or does not have a straight edge to guide along the fence.

If you do not have a clear understanding of kickback and how it occurs, DO NOT use this table saw.

REMAINING HAZARDS

The machine has been built in accordance with recognized safety standards. Some remaining hazards may still exist.

- The rotating saw blade can cause injuries to fingers and hands if the work piece is incorrectly fed.
- Thrown work pieces can lead to injury if the work piece is not properly secured or fed, such as working without a limit stop.
- Noise can be a health hazard. The permitted noise level is exceeded when working. Be sure to wear personal protective equipment such as ear protection.
- Defective saw blades can cause injuries. Regularly inspect the structural integrity of saw blades.
- The use of incorrect or damaged mains cables can lead to injuries caused by electricity.

Residual hazards can be minimized by following the instructions in the operating manual.

ELECTRICAL CONNECTIONS



WARNING! READ THESE ELECTRICAL SAFETY INSTRUCTIONS THOROUGHLY BEFORE CONNECTING THE PRODUCT TO THE MAINS SUPPLY.

Before switching the product on, make sure that the voltage of your electricity supply is the same as that indicated on the rating plate. This product is designed to operate on 230VAC 50Hz. Connecting it to any other power source may cause damage.

This product may be fitted with a non-rewireable plug. If it is necessary to change the fuse in the plug, the fuse cover must be refitted. If the fuse cover becomes lost or damaged, the plug must not be used until a suitable replacement is obtained.

If the plug has to be changed because it is not suitable for your socket, or due to damage, it should be cut off and a replacement fitted, following the wiring instructions shown below. The old plug must be disposed of safely, as insertion into a mains socket could cause an electrical hazard.

If the colours of the wires in the power cable of this product do not correspond with the markings on the terminals of your plug, proceed as follows.

- The **Blue** wire must be connected to the terminal marked **N** or coloured **Black**.
- The **Brown** wire must be connected to the terminal marked **L** or coloured **Red**.
- The **Yellow and Green** wire must be connected to the terminal marked **E** or  or coloured **Green**.

Plug must be BS1363/A approved.

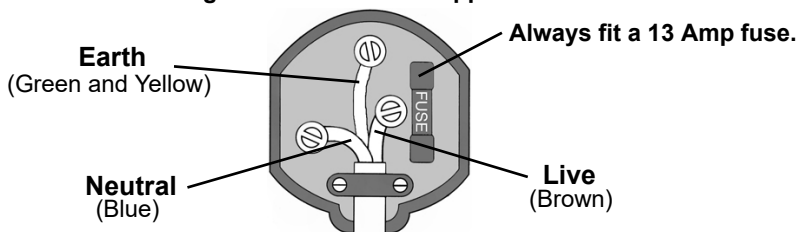

Ensure that the outer sheath of the cable is firmly held by the clamp

We strongly recommend that this machine is connected to the mains supply via a Residual Current Device (RCD). If in any doubt, consult a qualified electrician. DO NOT attempt any repairs yourself.

COMPONENT OVERVIEW

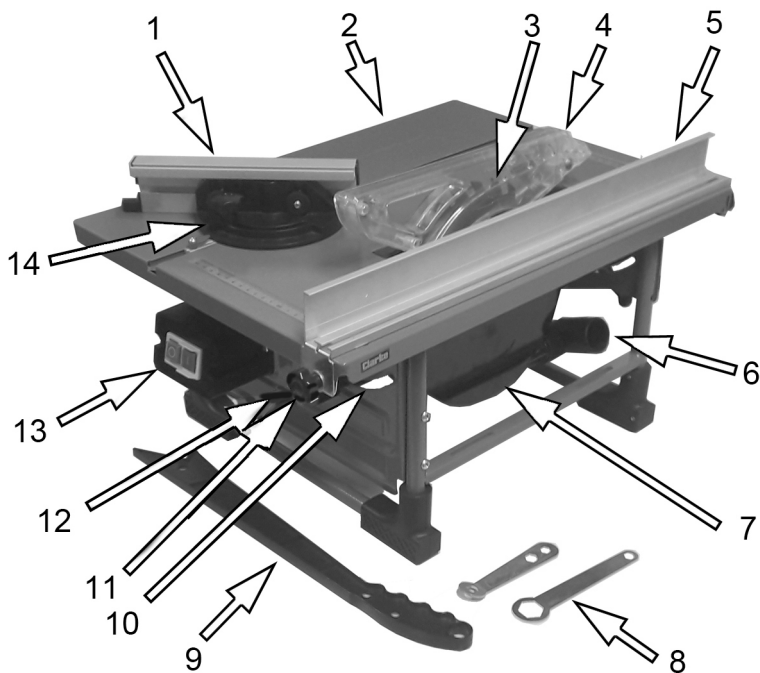

1	Mitre guide/cross cut fence	8	Blade removal wrenches
2	Work table	9	Push stick
3	Blade	10	Tilt angle scale
4	Blade Guard	11	Fence securing knob with clamp
5	Fence assembly	12	Tilt adjusting lever
6	Dust extract duct	13	Start/stop switch
7	Lower blade guard	14	Mitre square assembly

ASSEMBLY

The following items should be supplied in the carton. If any parts are missing, do not use your table saw until the missing parts are obtained.

1 x Table Saw	1 x Fixings Pack
1 x Parallel Guide Fence	1 x Push Stick
1 x Mitre Guide	1 x 8" TCT Blade (fitted)
1 x Guide fence	1 x Upper Blade Guard Assembly
2 x Wrenches (1 slotted/1 x Hex)	

FITTING THE PARALLEL FENCE

The parallel fence is essential to ensure straight line cutting and should always be used when rip sawing.

The fence is secured to the table with two knob head screws, acting on a pair of clamp plates, one at the front and one at the rear of the table.

The fence may be placed at any suitable position on the table, and either left or right of the saw blade. Do not over-tighten the securing knobs.

Measurement scales (in mm) are provided at the front and back of the table. These may be used to position the rip fence for rough cutting. If precision is required, use a ruler between the rip fence and the front and back of the blade.

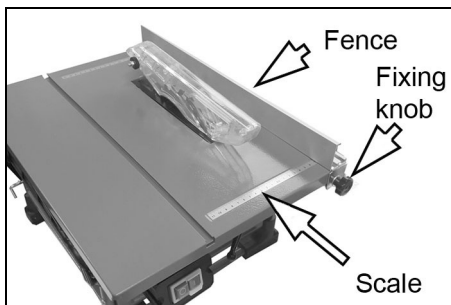

FITTING THE MITRE ASSEMBLY

1. Fit the fence to the mitre angle attachment. Slide the heads of the bolts into the channel in the fence and attach the thumb nuts. Drop the bolts/thumb nuts into the grooves in the mitre gauge and tighten to secure.
2. Slide the mitre attachment into the groove in the table top.

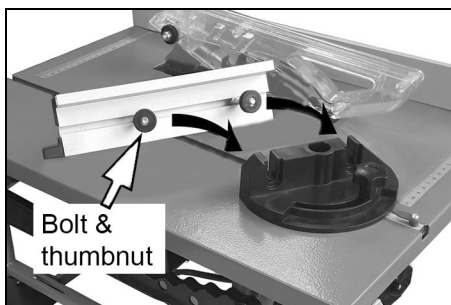

CONNECTING THE DUST EXTRACTION

This table saw is equipped with a dust extraction port under the machine. For safe operation, we recommend that a suitable dust extraction device or vacuum cleaner is connected during operation.

The machine is fitted with a dust extract point for anr extractor hose. (see specification).

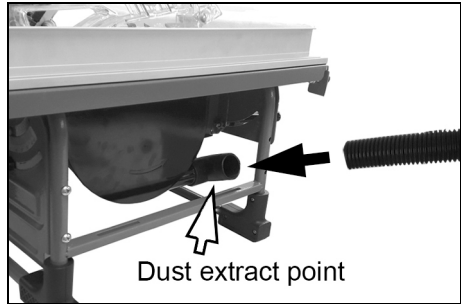

WARNING: EXCESSIVE SAWDUST BUILD UP AROUND THE MOTOR COULD POSSIBLY IGNITE AND CAUSE DAMAGE TO EITHER THE MOTOR, TABLE SAW OR YOUR WORKSHOP.

BEFORE STARTING WORK

All covers including the blade cover guard and side cover have to be properly fitted before switching on.

When working with wood that has been used before, remove all foreign bodies such as nails or screws etc before cutting.

Before you switch on, check that the saw blade is correctly fitted as shown on page 18 and turns smoothly.

Before connecting the saw to the power supply, en sure the data on the product label is the same as that for your mains supply.

Always stand the table saw on a flat and firm surface.



OPERATION



CAUTION: BEFORE STARTING UP THE SAW ALWAYS CHECK THE FOLLOWING POINTS:

1. Is the saw blade firmly tightened?
2. Are all the locking levers firmly locked?
3. Is the riving knife aligned with the saw blade? (see page 19)
4. Is the saw blade guard fitted?
5. Make sure that the fences are not touching the saw blade.
6. Can the saw blade rotate freely?
7. Are there any wood pieces jammed between the saw blade and the table?
8. Have all loose workpieces been removed from the table saw?
9. Have all the setting tools been removed?
10. Wear protective goggles, ear protection and dust mask.

ON/OFF SWITCH

1. To turn the saw on, press the green button "I".
 - Wait for the blade to reach its maximum speed before making the cut.
2. To turn the saw off again, press the red button "0".

NOTE: The blade will spin for several seconds after the machine is switched off.

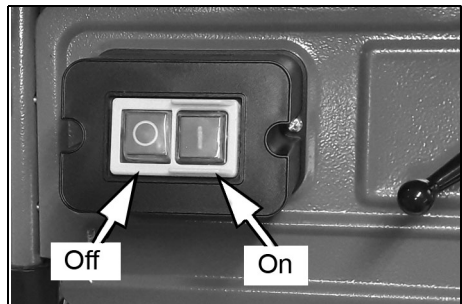

IMPORTANT: *The guard must always be lowered over the workpiece before you begin to cut.*

ADJUSTMENTS

After every new adjustment, we recommend you to make a trial cut in order to check the new settings.

PARALLEL FENCE

The parallel fence can be mounted on either side of the table. If you change the side, you will need to fit the fence the other way round.

1. Engage the parallel fence over the ends of the table.
2. Use the scale on the table to set the parallel fence to the required distance from the blade.
3. Lock the parallel fence in the required position by tightening the knob at each end.

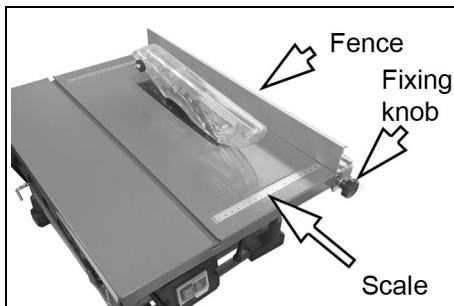

MITRE GAUGE

1. Insert the guide bar into the groove in the table top.
2. Loosen the knob to set the angle required.
3. Rotate until the pointer points to the angle on the scale you want.
4. Retighten the knob.
 - If required you can remove the fence from the mitre assembly using the 2 locking knobs, or slide it in either direction to suit the task before re-tightening.

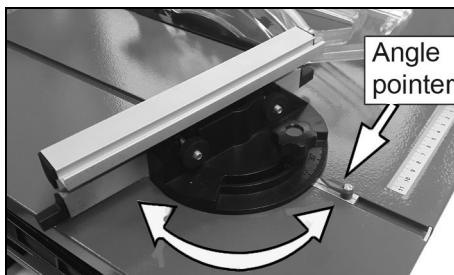

SETTING THE BLADE ANGLE

1. Release the bevel locking handle.
2. Tilt the saw blade and motor assembly until the saw blade is at the desired angle.
3. Tighten the bevel lock to lock the blade at the required angle shown on the scale.

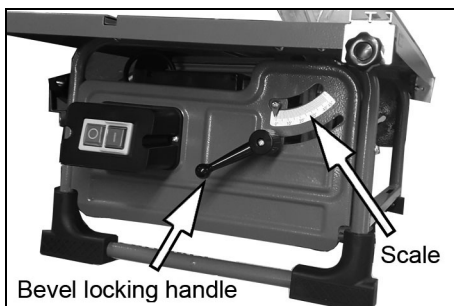

CUTTING TIPS

RIPPING CUTS & CROSS CUTS

Ripping is when you use the saw to cut along the grain of the wood.

The parallel fence must always be used when making ripping cuts.

1. Press one edge of the workpiece against the parallel fence while the flat side lies on the saw table.
 - The blade guard must always be lowered over the workpiece and blade.
 - When you make a ripping cut, never stand in line with the blade.
2. Set the parallel fence in accordance with the desired width.
3. Switch on the saw.
4. Place your hands (with fingers closed) flat on the workpiece and push the workpiece along the parallel fence towards the blade.
5. Guide at the side with your left or right hand (depending on the position of the parallel fence) only as far as the front edge of the guard hood.
6. Always push the workpiece through to the end of the riving knife using a push stick.
7. Do not remove the offcut piece until the blade has stopped spinning.
8. Secure long workpieces against falling off at the end of the cut (e.g. with a roller stand etc).



CUTTING NARROW WORKPIECES

Always use a push stick when the workpiece is narrow and for holding the workpiece flat on the table.

IMPORTANT: Take extra care to keep you thumbs away from the saw blade when feeding the workpiece past the blade.



When not in use, place the push stick in its storage clip on the side of the saw.

Replace a damaged push stick immediately.

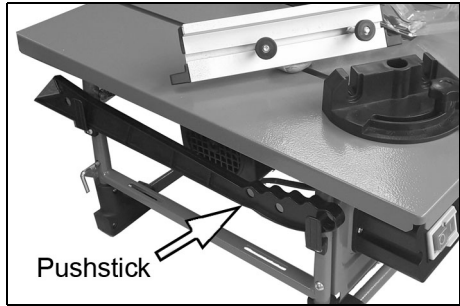

MITRE CUTS

1. Slide the mitre gauge into the groove in the table.
2. Adjust the mitre gauge to the required angle.
3. Press the workpiece firmly against the mitre gauge.
4. Switch on the saw.
5. Push the mitre gauge and the workpiece toward the blade to make the cut.

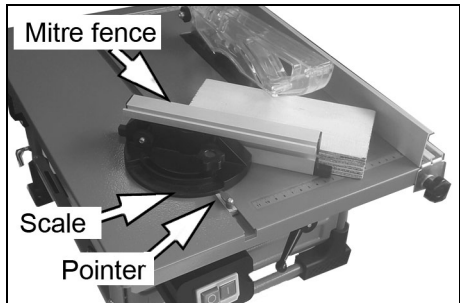

IMPORTANT: Always hold the guided part of the workpiece. Never hold the part which is to be cut off.

6. Push the mitre gauge forward until the workpiece is cut all the way through.
7. Switch off and do not remove the offcut until the blade has stopped turning.

BEVEL CUTS

Bevel cuts must always be made using the parallel fence.

1. Undo the bevel lock levers at each end of the saw.
2. Set the saw to the desired angle on the scale.
3. Tighten the bevel locks to lock the blade at the selected angle.
4. Set the parallel fence.
5. Perform the cut as you would for a ripping cut.

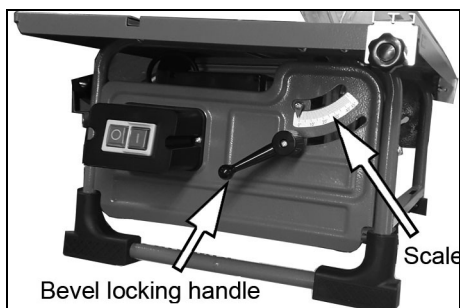

NOTE: If precision is required, use a protractor between the blade and table.

MAINTENANCE



WARNING: REMOVE THE PLUG FROM THE MAINS POWER SUPPLY BEFORE CARRYING OUT ANY ADJUSTMENT OR MAINTENANCE.

1. Remove dust regularly from the machine. Cleaning is best carried out with a fine brush.
2. Use a half-round file where necessary to keep the teeth sharp. A blade that is badly dulled or with damaged teeth should be replaced immediately.
 - Never use caustic agents to clean plastic parts.

CHANGING THE BLADE



WARNING: REMOVE THE PLUG FROM THE MAINS SUPPLY BEFORE CARRYING OUT ANY ADJUSTMENT, SERVICING OR MAINTENANCE.

1. Remove the side cover by unscrewing the two securing screws.
2. Using the two wrenches provided, hold the spindle to prevent the motor from turning and undo the the saw blade securing nut - normal right hand thread.
3. Remove the outer retaining disc followed by the saw blade by angling it outwards at the bottom so that it is clear of the motor shaft and carefully withdrawing it from below.
4. Replace in reverse order ensuring the saw blade teeth face downwards at the front of the table.
 - The arrow on the face of the blade will show the rotation to be anticlockwise.
5. Hold the blade firmly when tightening the centre nut, taking care to avoid damaging your hand on the sharp teeth.

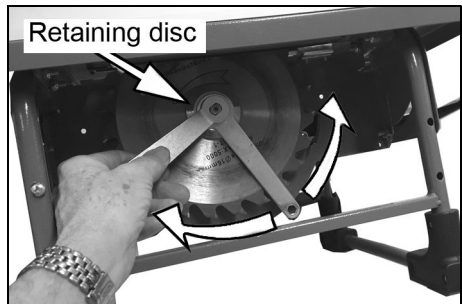

IMPORTANT: Note the running direction. The cutting angle of the teeth must point in the running direction, i.e. forwards (see arrow on the blade guard).

RIVING KNIFE ALIGNMENT



WARNING: CHECK THE ALIGNMENT OF THE RIVING KNIFE EACH TIME THE SAW BLADE IS REPLACED.

6. Check that the riving knife lines up with the saw blade. If not proceed as follows.
7. Remove the blade guard (by releasing the hinge bolt if tight) and lifting it clear of the slot in the riving knife as shown.
 - If the hinge bolt is loose, it should just lift away.
8. Remove the two screws that secure the table insert and lift it away.
9. Loosen the screws that hold the riving knife and adjust the riving knife position until central.
10. Retighten the screws.
11. Replace the table insert.
12. Replace the saw blade guard.
13. Check to make sure that all components are properly mounted and in good working condition before you begin working with the saw again.

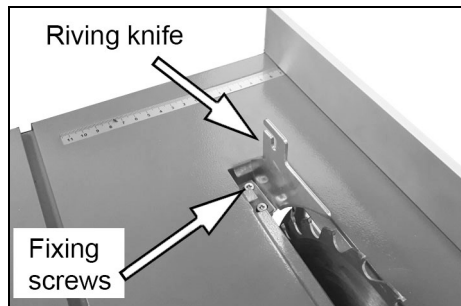
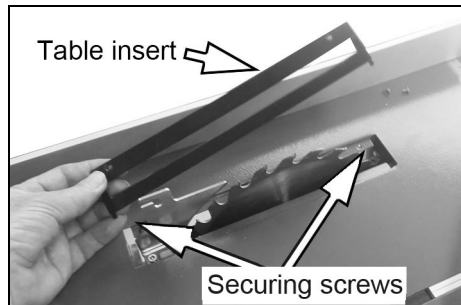
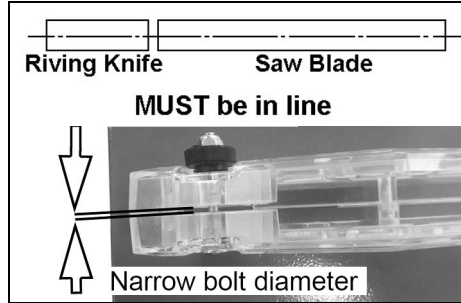

TROUBLE SHOOTING

Problem	Probable cause	Solution
Saw will not start	<ol style="list-style-type: none"> 1. Saw not plugged in 2. Fuse blown 3. Power cable damaged 	<ol style="list-style-type: none"> 1. Plug in the machine 2. Replace fuse 3. Have cable replaced by your dealer.
Does not make accurate 45° and 90° cuts	<ol style="list-style-type: none"> 1. Table adjuster not set correctly 	<ol style="list-style-type: none"> 1. Check blade with a set square and adjust pointer to zero.
Material pinches blade	<ol style="list-style-type: none"> 1. Fence not aligned with blade. Warped wood. Edge not set square to fence. 	<ol style="list-style-type: none"> 1. Check and adjust fence. Select another piece of wood
Material binds on the riving knife	<ol style="list-style-type: none"> 1. Riving knife not aligned correctly 	<ol style="list-style-type: none"> 1. Check that riving knife is correctly aligned with blade
Saw makes unsatisfactory cuts	<ol style="list-style-type: none"> 1. Dull blade 2. Blade mounted backwards 3. Gum or pitch on blade 4. Incorrect blade for work 5. Gum or pitch on table causing erratic feed 	<ol style="list-style-type: none"> 1. Replace blade 2. Turn blade around 3. Remove blade and clean with turpentine and coarse steel wool 4. Change the blade 5. Clean table with turpentine and steel wool and apply wax
Material kicked back from blade slot	<ol style="list-style-type: none"> 1. Rip fence out of alignment 2. Riving knife not aligned with blade 3. Feeding stock without rip fence 4. Riving knife not in place 5. Letting go of wood before it is all the way past the saw blade 6. Dull blade 	<ol style="list-style-type: none"> 1. Align rip fence with blade 2. Align riving knife with blade 3. Install and use rip fence 4. Install and use riving knife with guard 5. Push work fully past blade before releasing work 6. Replace blade
Blade does not tilt freely	<ol style="list-style-type: none"> 1. Sawdust in tilting mechanism 	<ol style="list-style-type: none"> 1. Brush or blow out loose dust
Blade does not come up to speed	<ol style="list-style-type: none"> 1. Extension cable too long 	<ol style="list-style-type: none"> 1. Replace or use shorter cable
Machine vibrates	<ol style="list-style-type: none"> 1. Saw not standing securely on bench 2. Damaged saw blade 	<ol style="list-style-type: none"> 1. Reposition on flat level surface 2. Replace blade.
Does not make accurate 45° and 90° cuts	<ol style="list-style-type: none"> 1. Mitre gauge out of adjustment 	<ol style="list-style-type: none"> 1. Adjust mitre gauge

PARTS DIAGRAM

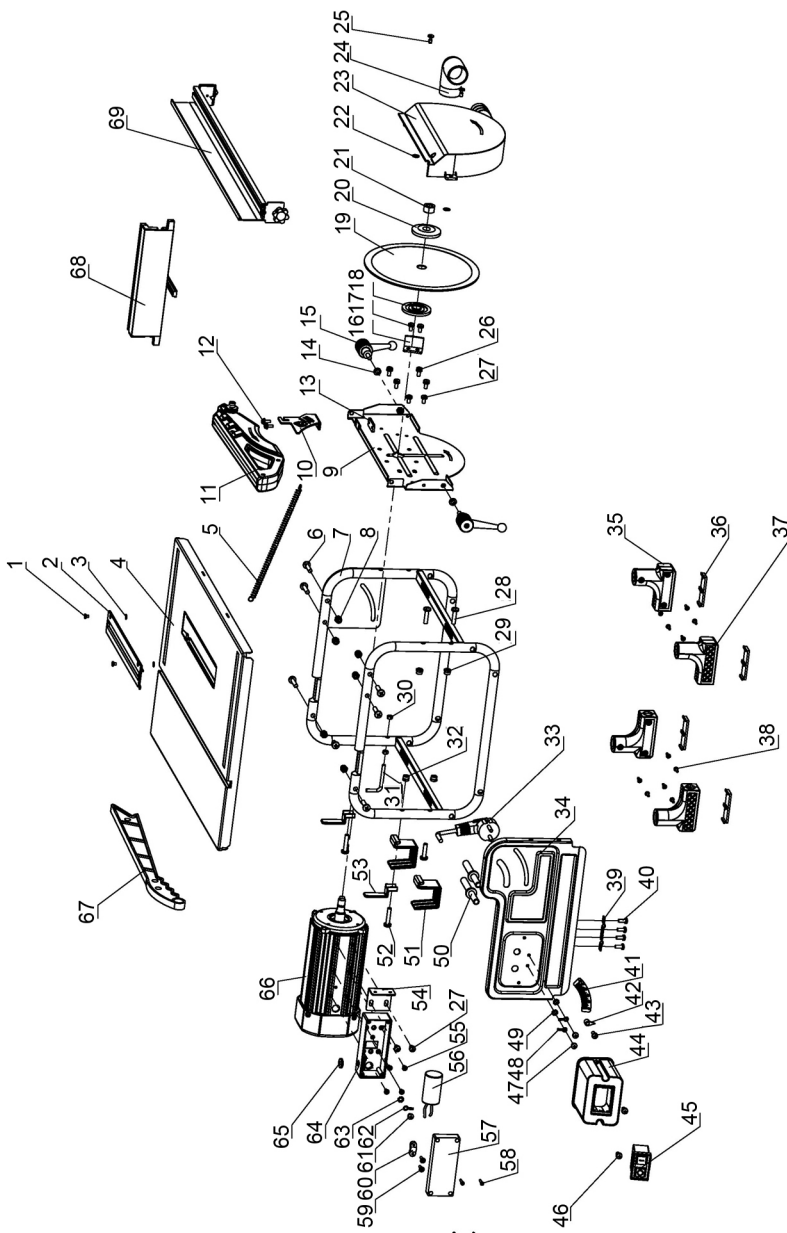

PARTS LIST

No	Item	No	Item	No	Item
1	C/s screw M4x6	24	Dust extractor joint	48	Earth connector
2	Table insert	25	Screw M5x12	49	Tooth washer 5#
3	Backing plate	26	Bolt M5x12	50	Cable sleeve
4	Work table	27	Bolt M5x10	51	Hook
5	Tension spring	28	Bolt M6x25	52	Bolt M6x30
6	Bolt M6x25	29	Locknut M6	53	Push stick clip
7	Side frame	30	Nut M5	54	Motor bracket
8	Lock nut M6	31	Right angle hook	55	C/s screw M4x8
9	Motor support plate	32	Locknut	56	Capacitor
10	Riving knife	33	Power cable & plug	57	Capacitor cover
11	Blade cover guard	34	Front cover plate	58	Self tapping screw
12	Bolt M4x12	35	Rubber foot LH	59	Screw & washer
13	Backing plate	36	Rubber pad	60	Connecting piece
14	Washer 6#	37	Rubber foot RH	61	Bolt/ spring washer
15	Tilt locking handle	38	Screw & washer	62	Ground plate
16	Blade stop plate	39	Clamp plate	63	Tooth washer
17	Bolt & washer M5x10	40	Screw M5x12	64	Capacitor box
18	Inner retaining disc	41	Tilt angle label	65	Cable protector
19	Saw blade	42	Pointer	66	Motor
20	Outer retaining disc	44	Switch box	67	Push stick
21	Nut M12	45	Switch	68	Mitre fence
22	Backing plate	46	Screw M5x10	69	Parallel fence
23	Side guard	47	Bolt & spring washer		

DECLARATION OF CONFORMITY



Fitzwilliam Hall, Fitzwilliam Place, Dublin 2

DECLARATION OF CONFORMITY

This is an important document and should be retained.

We hereby declare that this product(s) complies with the following directive(s):

- 2014/30/EU Electromagnetic Compatibility Directive.
- 2006/42/EC Machinery Directive.
- 2017/65/EU Restriction of Hazardous Substances, (amended by 2015/863).

The following standards have been applied to the product(s):

- EN 62841-1:2015, EN 62841-3-1:2014+A11:2017, EN 55014-1:2017, EN 55014-2:2015,
- EN 61000-3-2:2014, EN 61000-3-3:2013.

The technical documentation required to demonstrate that the product(s) meet(s) the requirement(s) of the aforementioned directive(s) has been compiled and is available for inspection by the relevant enforcement authorities Annex IV, Notified Body: TÜV SÜD Product Service GmbH, Rinderstraße 65, D-80333 München, Germany, EC Type-Examination Certificate No.: MGA 055256 Rev.0, Notified Body No.: 0123

The CE mark was first applied in: 2021

Product Description: 200 mm Electric Table Saw
 Model number(s): CTS600C
 Serial / batch Number: N/A
 Date of Issue: 22/02/2021

Signed:

J.A. Clarke
 Director



Hemond Street, Esping, Essex, CM16 4QG

DECLARATION OF CONFORMITY

This is an important document and should be retained.

We hereby declare that this product(s) complies with the following UK legislation:

- Electromagnetic Compatibility Regulations 2016.
- Supply of Machinery (Safety) Regulations 2008.
- The Restriction of the Use of Certain Hazardous Substances in Electrical and Electronic Equipment Regulations 2012.

The following standards have been applied to the product(s):

- EN 62841-1:2015, EN 62841-3-1:2014+A11:2017, EN 55014-1:2017, EN 55014-2:2015,
- EN 61000-3-2:2014, EN 61000-3-3:2013.

The technical documentation required to demonstrate that the product(s) meet(s) the requirement(s) of the aforementioned directive(s) has been compiled and is available for inspection by the relevant enforcement authorities Annex IV, Notified Body: TÜV SÜD Product Service GmbH, Rinderstraße 65, D-80333 München, Germany, EC Type-Examination Certificate No.: MGA 055256 Rev.0, Notified Body No.: 0123

This product was placed onto the market: 2021

Product Description: 200 mm Electric Table Saw
 Model number(s): CTS600C
 Serial / batch Number: N/A
 Date of Issue: 22/02/2021

Signed:

J.A. Clarke
 Director

A SELECTION FROM THE VAST RANGE OF

Clarke®

QUALITY PRODUCTS



AIR COMPRESSORS

From DIY to industrial, Plus air tools, spray guns and accessories.

GENERATORS

Prime duty or emergency standby for business, home and leisure.

POWER WASHERS

Hot and cold, electric and engine driven - we have what you need

WELDERS

Mig, Arc, Tig and Spot. From DIY to auto/industrial.

METALWORKING

Drills, grinders and saws for DIY and professional use.

WOODWORKING

Saws, sanders, lathes, mortisers and dust extraction.

HYDRAULICS

Cranes, body repair kits, transmission jacks for all types of workshop use.

WATER PUMPS

Submersible, electric and engine driven for DIY, agriculture and industry.

POWER TOOLS

Angle grinders, cordless drill sets, saws and sanders.

STARTERS/CHARGERS

All sizes for car and commercial use.

PARTS & SERVICE:

0208 988 7400

Parts Enquiries

Parts@clarkeinternational.com

Servicing & Technical Enquiries

Service@clarkeinternational.com

SALES: UK 01992 565333 or Export 00 44 (0)1992 565335

Clarke INTERNATIONAL Hemnall Street, Epping, Essex CM16 4LG
www.clarkeinternational.com